

TOP VIEW

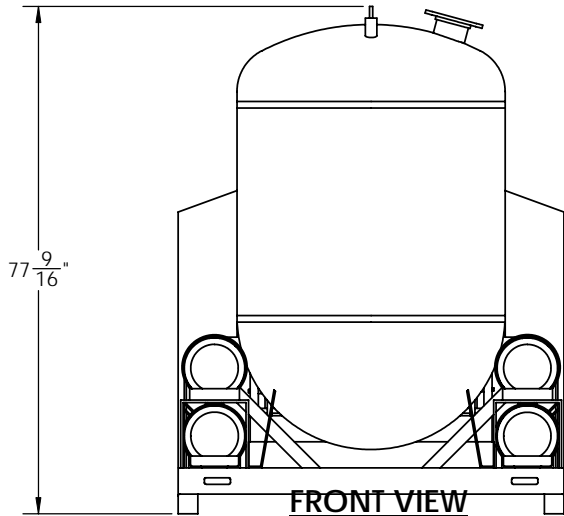

FRONT VIEW

BURNER FIRE CONTROL

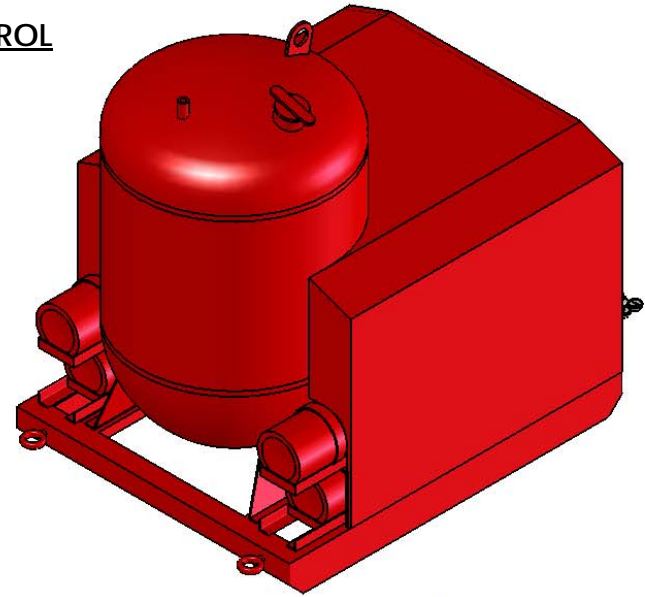

ISOMETRIC VIEW

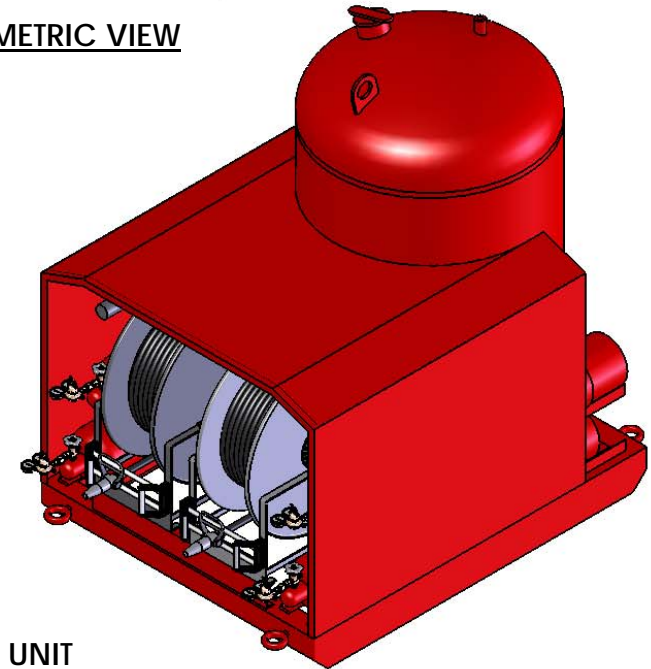

2500 LB DRY CHEMICAL UNIT